

DIO2352A/B

Ultra Low Vos, 2.5kHz, RRIO CMOS High-Precision Amplifier

Features

- Rail-to-Rail Input and Output
- Low offset (V_{OS}): $\pm 13\mu V$
- Gain Error: $\pm 1\%$
- Input offset drift: $0.01\mu V/^{\circ}C$ (Max)
- Gain drift: $10ppm/^{\circ}C$ (Max)
- Gain Selection:
 - DIO2352A: 50V/V
 - DIO2352B: 100V/V
- Wide supply range: 2.5V to 5.5V
- Single Supply Operation
- Quiescent Current: $730\mu A$ (Typ)
- Available Packages: SOIC-8, TSSOP-8, DFN-8

Descriptions

The DIO2352X is an ultra-low offset voltage rail-to-rail input and output voltage feedback amplifier. They have a wide input common-mode voltage range and output voltage swing, and take the operating supply voltage is from 2.5 to 5.5V.

The DIO2352X features an offset voltage of only $13\mu V$ and drift of $0.01\mu V/^{\circ}C$, which makes the product perfect in applications of intolerant errors. Temperature/position/pressure sensors and medical equipment can benefit greatly from nearly zero drift over their operating temperature range.

Applications

- Notebook Computer
- Mobile Phone
- Power Management IC
- Battery Charger
- Welding Equipment

Typical Application

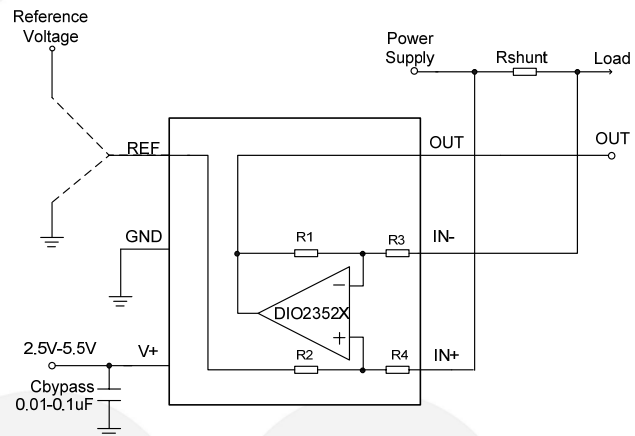

Ordering Information

Order Part Number	Top Marking		T_A	Package	
DIO2352ASO8	DIO2352A	Green/RoHS	-40 to +125 $^{\circ}C$	SOIC-8	Tape & Reel, 2500
DIO2352BSO8	DIO2352B	Green/RoHS	-40 to +125 $^{\circ}C$	SOIC-8	Tape & Reel, 2500
DIO2352ATP8	DIO2352A	Green/RoHS	-40 to +125 $^{\circ}C$	TSSOP-8	Tape & Reel, 3000
DIO2352BTP8	DIO2352B	Green/RoHS	-40 to +125 $^{\circ}C$	TSSOP-8	Tape & Reel, 3000
DIO2352AED8	23A	Green/RoHS	-40 to +125 $^{\circ}C$	DFN-8	Tape & Reel, 3000
DIO2352BED8	23B	Green/RoHS	-40 to +125 $^{\circ}C$	DFN-8	Tape & Reel, 3000

Pin Assignments

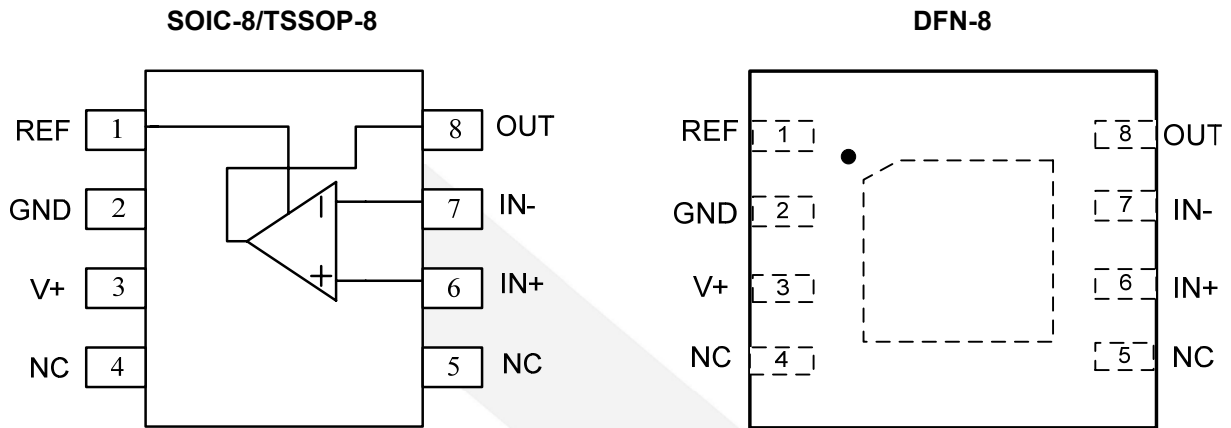

Figure 1 Pin Assignment

Pin Description

Pin name	Description
V+	Positive supply
GND	Negative supply
IN+	Positive Input
IN-	Negative Input
OUT	Output
REF	Reference Input
NC	No connect

Absolute Maximum Ratings

Stresses beyond those listed under “Absolute Maximum Rating” may cause permanent damage to the device. These are stress ratings only and functional operation of the device at these or any other condition beyond those indicated in the operational sections of the specifications is not implied. Exposure to absolute maximum rating conditions for extended periods may affect device reliability.

Parameter		Rating	Unit
Supply Voltage		7.5	V
Input Voltage		$(-V_S)-0.5$ to $(+V_S)+0.5V$	V
Storage Temperature Range		-65 to 150	°C
Junction Temperature		150	°C
Lead Temperature Range		260	°C
ESD	HBM, JEDEC: JESD22-A114	8	kV
	CDM, JEDEC: JESD22-C101	2	

Recommended Operating Conditions

The Recommended Operating Conditions table defines the conditions for actual device operation to ensure optimal performance to the datasheet specifications. DIOO does not recommend exceeding them or designing to Absolute Maximum Ratings.

Parameter		Rating	Unit
Supply Voltage		2.5 to 5.5	V
Input Voltage		0 to 5	V
Operating Temperature Range		-40 to 125	°C



Electrical Characteristics

$V_{+}=+5V$, $V_{REF}=V_S/2$, $T_A = 25^{\circ}C$, unless otherwise specified.

Symbol	Parameter	Conditions	Min.	Typ.	Max.	Unit
INPUT CHARACTERISTICS						
V_{CM}	Common Mode Input Current		-0.1		(V+)+ 0.1	V
CMRR	Common Mode Rejection Ratio	$V_{CM}=-0.1$ to (V+)+0.1		100		dB
V_{OS}	Input Offset Voltage	Common voltage= V_S	-80	30	+80	μV
		Common voltage= $V_S/2$	-20	13	20	
PSRR	Power Supply Rejection Ration	$V_S=2.7V$ to 5.5V		100		dB
I_B	Input Bias Current			5		μA
I_{OS}	Input Offset Current			20		pA
$\Delta V_{OS}/\Delta T$	Input Offset Voltage Drift	$-40^{\circ}C \leq T_A \leq 125^{\circ}C$		0.01		$\mu V/^{\circ}C$
	Gain Drift			3	10	ppm/ $^{\circ}C$
Gain		DIO2352A		50		V/V
		DIO2352B		100		V/V
OUTPUT CHARACTERISTICS						
V_{OH}	Output Voltage High	$R_L=100k\Omega$, $-40^{\circ}C \leq T_A \leq 125^{\circ}C$		4.998		V
		$R_L=10k\Omega$, $-40^{\circ}C \leq T_A \leq 125^{\circ}C$		4.99		
V_{OL}	Output Voltage Low	$R_L=100k\Omega$, $-40^{\circ}C \leq T_A \leq 125^{\circ}C$		1.2		mV
		$R_L=10k\Omega$, $-40^{\circ}C \leq T_A \leq 125^{\circ}C$		7.3		
I_O	Output Current	Source Current		50		mA
		Sink Current		50		
I_S	Supply Current	$-40^{\circ}C \leq T_A \leq 125^{\circ}C$		730		μA
GBP	Gain Bandwidth Product			2.5		kHz
NOISE PERFORMANCE						
THD	Total Harmonic Distortion	f=1kHz, 2V Output Step, $R_L=10k\Omega$,		0.0014		%
e_n	Voltage Noise Density	f=1kHz		40		nV/kHz

Specifications subject to change without notice.

Typical Performance Characteristics

$V_{+}=+5V$, $V_{REF}=V_S/2$, $T_A = 25^{\circ}C$, unless otherwise specified.

Supply Voltage & Current

Supply Voltage vs. Supply Current

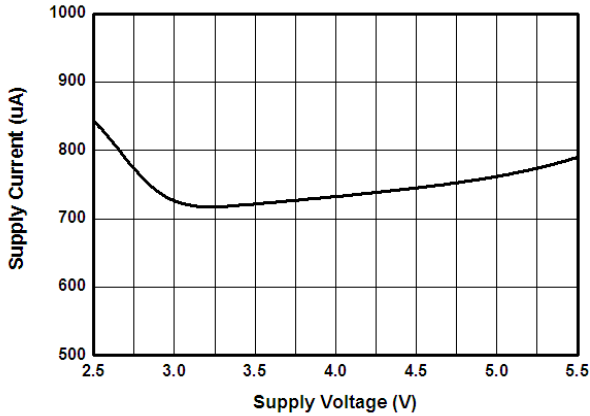

ICC & Temperature

ICC vs. Temperature

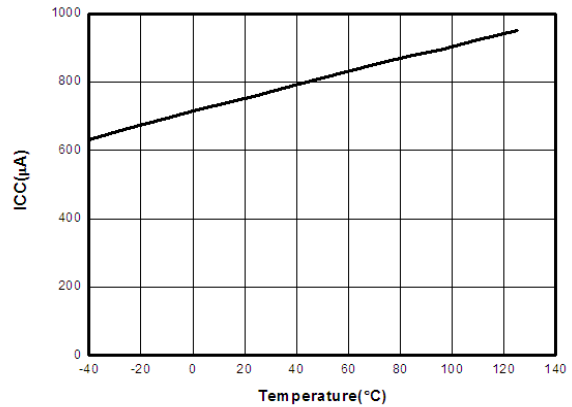

GBW & Frequency (G=100)

GBW vs. Frequency

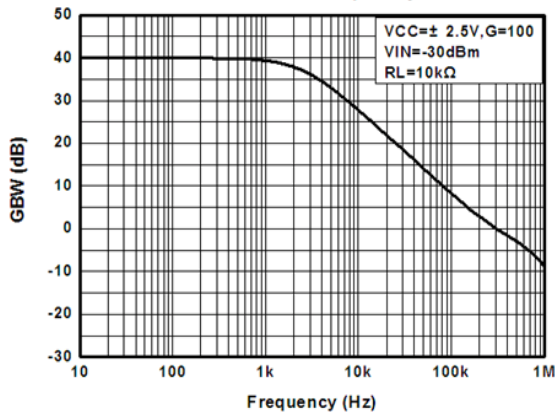

GBW & Frequency (G=50)

GBW vs. Frequency

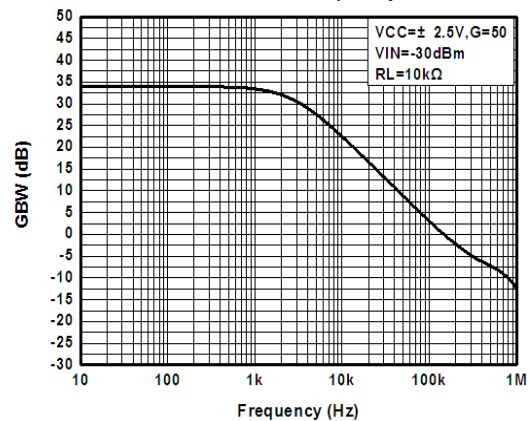

CMRR & Frequency

CMRR vs. Frequency

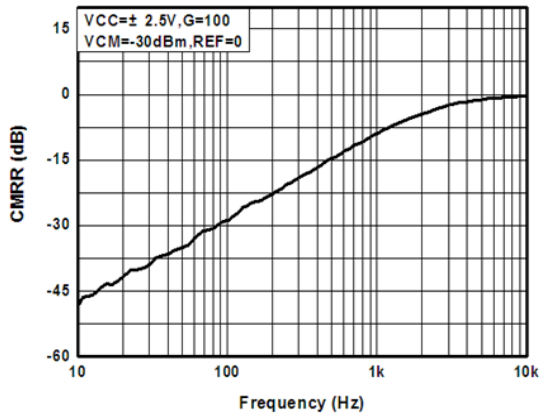

PSRR & Frequency

PSRR vs. Frequency

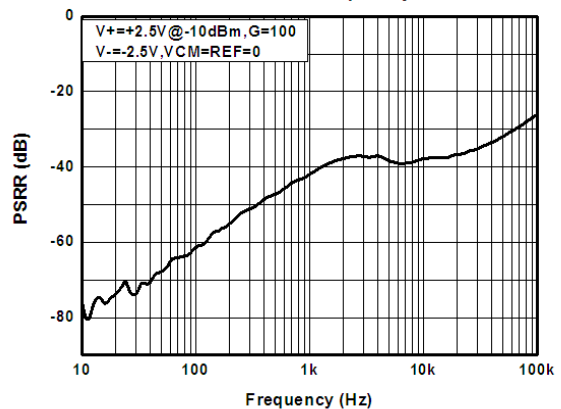

Large Signal Response

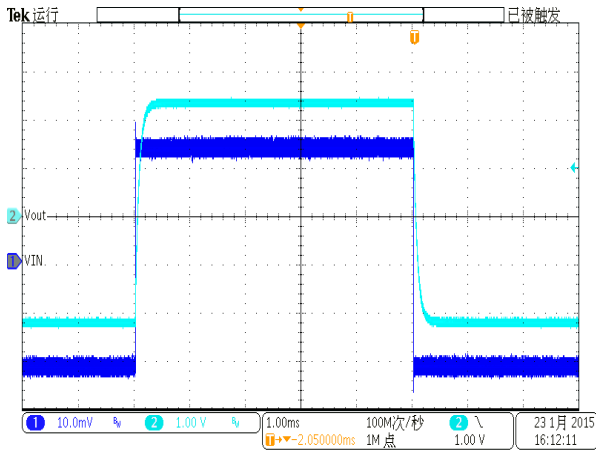

Over Load Recovery Time

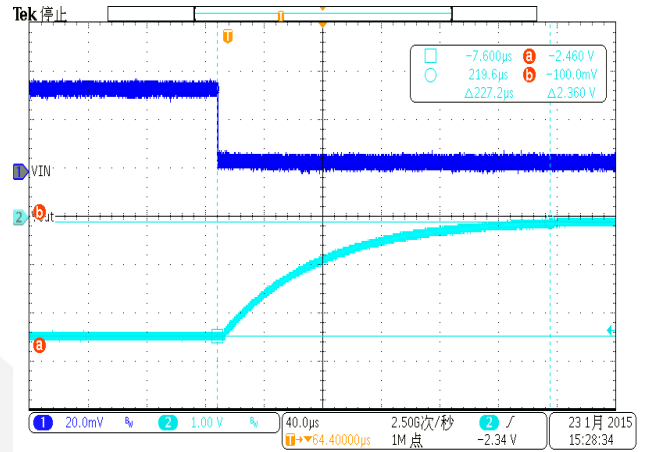

Over Load Recovery Time

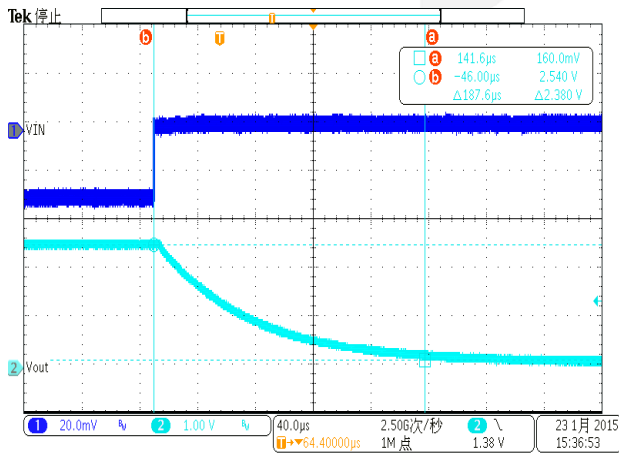



DIO2352X

Ultra Low V_{os} , 2.5KHZ, RRIO CMOS High-Precision Amplifier

CONTACT US

Dioo is a professional design and sales corporation for high-quality and performance analog semiconductors. The company focuses on industry markets, such as, cell phone, handheld products, laptop, and medical equipment and so on. Dioo's product families include analog signal processing and amplifying, LED drivers and charger IC. Go to <http://www.dioo.com> for a complete list of Dioo product families.

For additional product information, or full datasheet, please contact with our Sales Department or Representatives.

dioo